

**STEP 2**

Attach and secure **Wooden Slats** onto both **Side Rails** by using **(B)**, tighten it up by using a Crosshead Screw Driver.

# ASSEMBLY INSTRUCTION

MODEL : WS 1604 CHARLESTON 3' BED (915 x 1905)MM

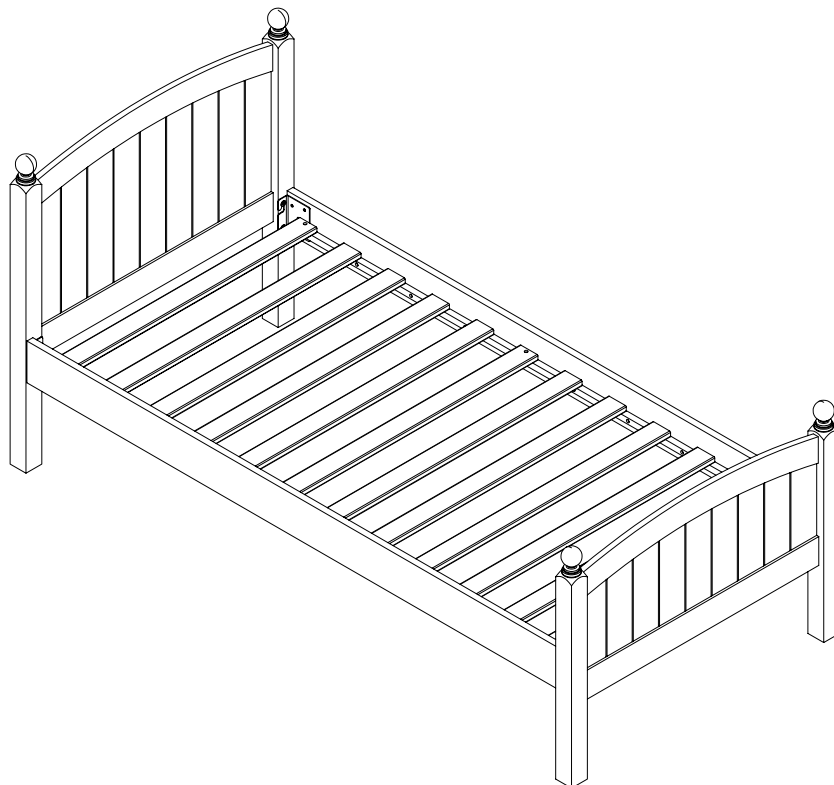

## HARDWARE LIST

**A**  **8 PCS**  
JCBB BOLT (M8 x 20MM)

**B**  **6 PCS**  
CSK C/B SCREW (M4 x 32MM)

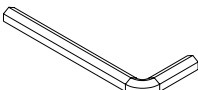
**C**  **1 PC**  
ALLEN KEY (M5 x 60MM)

**Tool Required :** Crosshead Screw Driver

## PARTS LIST

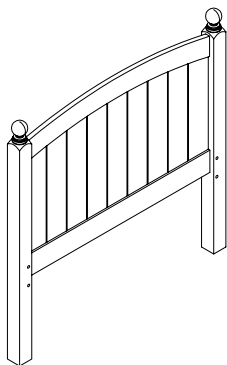

**HEADBOARD**  
1 PC / SET  
(CARTON 1 OF 2)

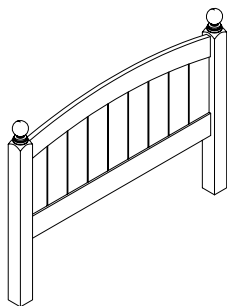

**FOOTBOARD**  
1 PC / SET  
(CARTON 1 OF 2)

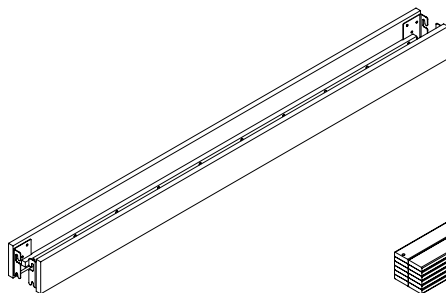

**SIDE RAILS**  
2 PCS / SET  
(CARTON 2 OF 2)

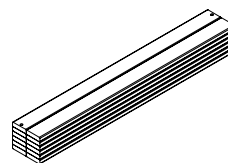

**WOODEN SLATS**  
12 PCS / SET  
(CARTON 1 OF 2)

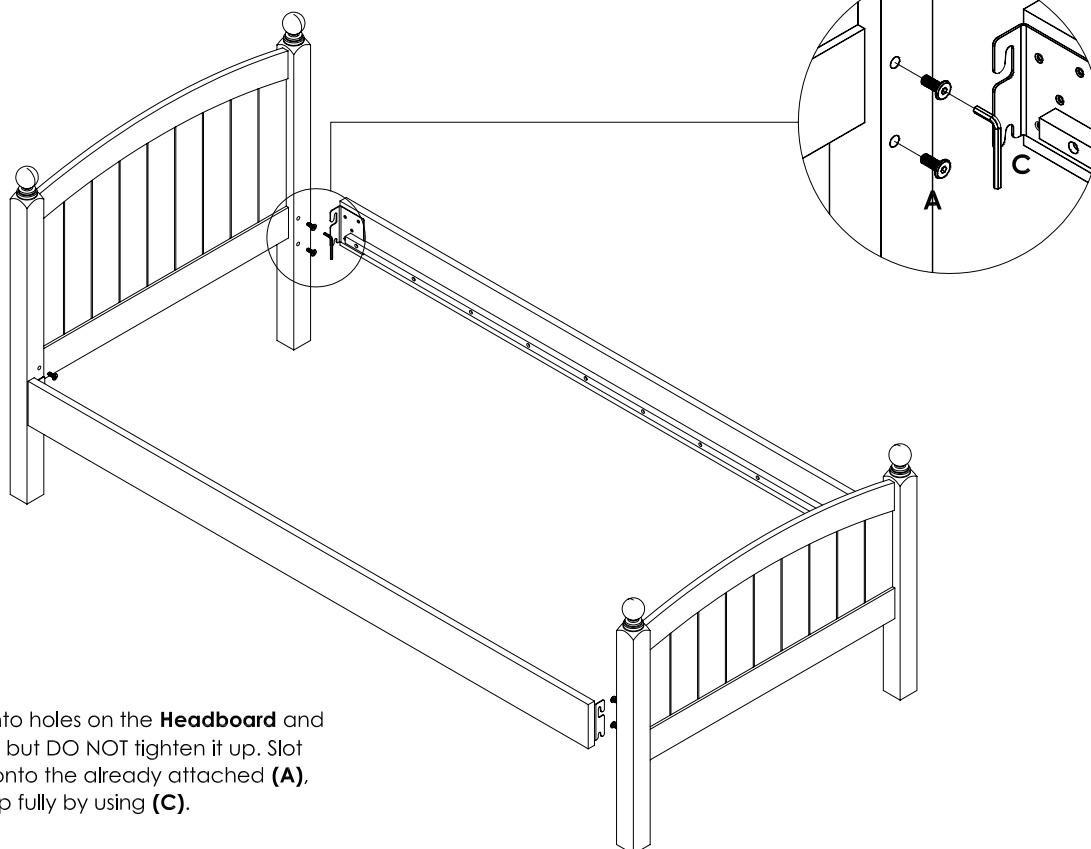

### STEP 1

Insert **(A)** into holes on the **Headboard** and **Footboard**, but DO NOT tighten it up. Slot **Side Rails** onto the already attached **(A)**, tighten it up fully by using **(C)**.